

SPECIFICATION FOR CERAMIC COB LED

Part No:LCOB35-20W030XXER80-0640

Description:

28*28mm COB LED

Dice Material: InGaN

Confirmed by Customer: _____

Approved by

Checked by

Prepared by

罗顺达

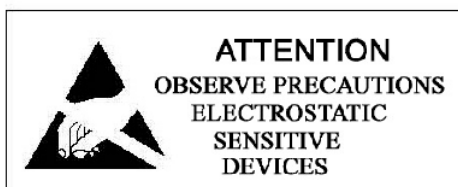

LCOB35-20W030XXER80

BS-High CRI Series COB LED



Introduction

Lightspot BS High CRI series LED Light engine is based on our main patent----- **MCOB** (**M**ulti-**C**hips **O**n **B**oard) . Lightspot LEDs combine tens or hundreds power LED chips with a rugged package capable of operating in excess of power . Lightspot LEDs maximumly decrease LED uncomfortable glare and also Zebra strips, at the same time increase LED light efficiency and reduce thermal resistance.

Features:

- ◇ Area light source, which can avoid glare
- ◇ More energy efficient than incandescent , halogen and some fluorescent lamps
- ◇ Industry's lowest thermal resistance
- ◇ Long operating life, lumen maintenance of greater than 70% after 50,000 hours
- ◇ Low forward voltage operated
- ◇ Instant light (less than 100ns)
- ◇ Lead Free product, RoHS compliant
- ◇ No UV

Application

- ◇ Automotive interior / exterior lighting
- ◇ Automotive signal lighting
- ◇ General Torch
- ◇ Architectural lighting
- ◇ LCD TV / Monitor Backlight
- ◇ Projector light source
- ◇ Traffic signals
- ◇ Task lighting
- ◇ Decorative / Pathway lighting
- ◇ Remote / Solar powered lighting
- ◇ Household appliances

Outline Dimensions:

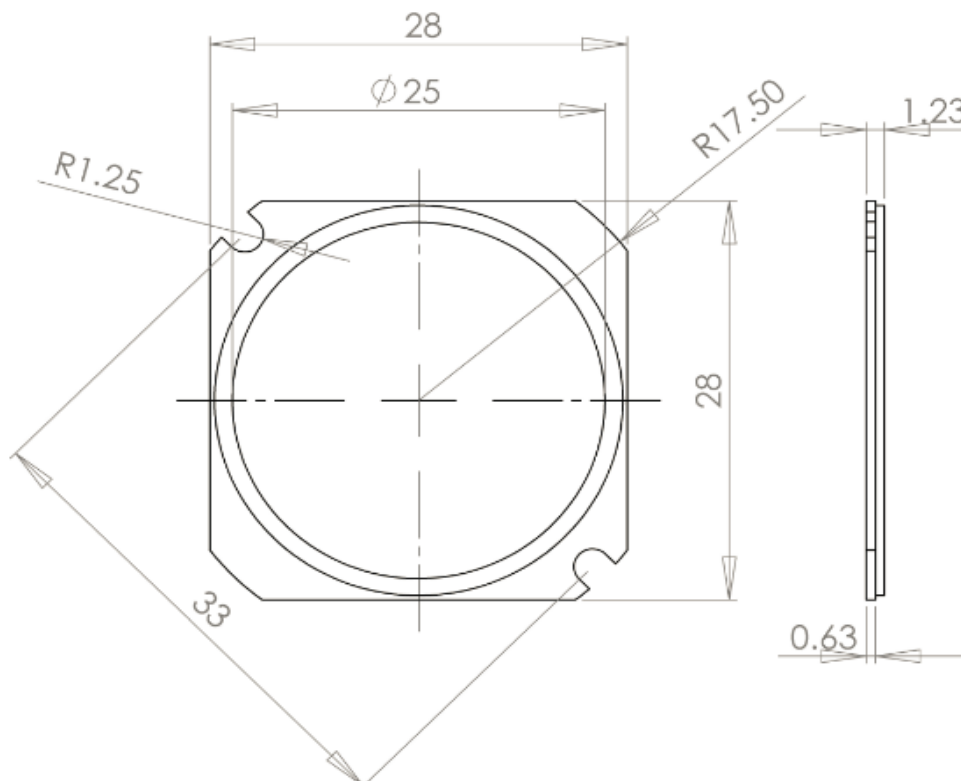

LCOB35-20W030XXER80

Absolute Maximum Ratings at $T_a=25^\circ\text{C}$:

Parameter	Part No.	Symbol	Maximum	Unit
Power Dissipation	LCOB35-20W030XXER80	Pd	20	W
Peak Forward Current (1/10 Duty Cycle, 0.1ms Pulse Width)		IF(peak)	800	mA
Continuous Forward Current		IF	640	mA
LED junction temperature		JT	120	°C
Reverse Voltage		VR	50	V
Thermal Resistance, junction to case	LCOB35-20W030XXER80	R θ j-c	2.5	°C/W
Soldering Temperature °C	5 seconds, 260°C or lower			
Operating temperature range		Topr	-30°C to + 85°C	
Storage Temperature Range		Tstg	-40°C to + 100°C	

● Warm white

Parameter	Part No.	Symbol	Test Condition	Min.	Typ.	Max.	Unit
Luminous flux	LCOB35-20W030XXER80	ϕ	I _F =640mA	1450	/	1900	lm
Viewing Angle		2 θ 1/2			140		deg
Forward Voltage		V _F	I _F =640mA	30	/	36	V
Reverse Current		I _R	V _R =50V			100	uA
Correspondingly		CCT		2870	3045	3220	K
Color Rendering Index		CRI		80	/	85	

- 1、The luminous intensity data did not include $\pm 10\%$ testing tolerance.
- 2、Tolerance of CRI is ± 2 .

Relative Spectral Power Distribution

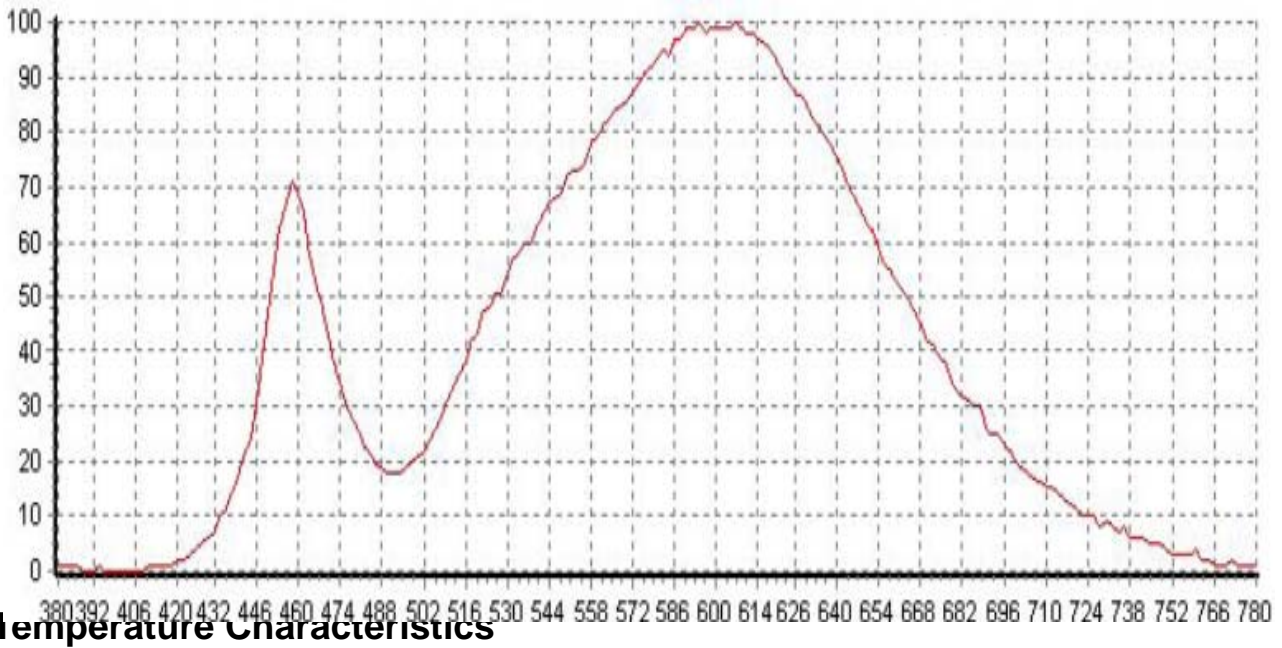

Relative Luminous Flux(@640mA) vs. Tp Temperature

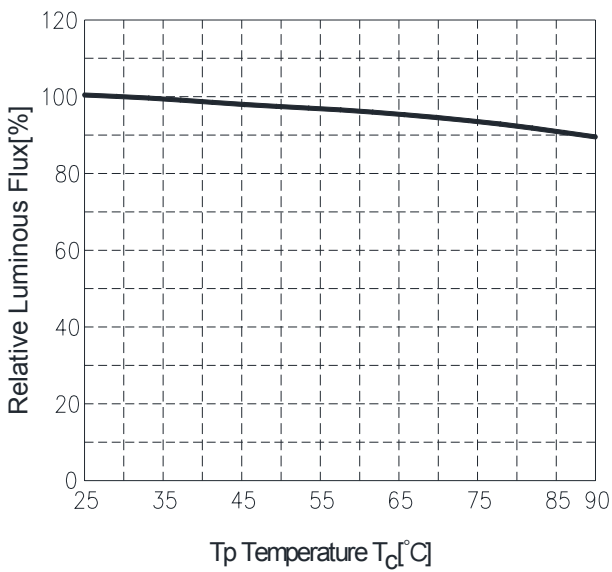

Forward Voltage (@640mA) vs. Tp Temperature

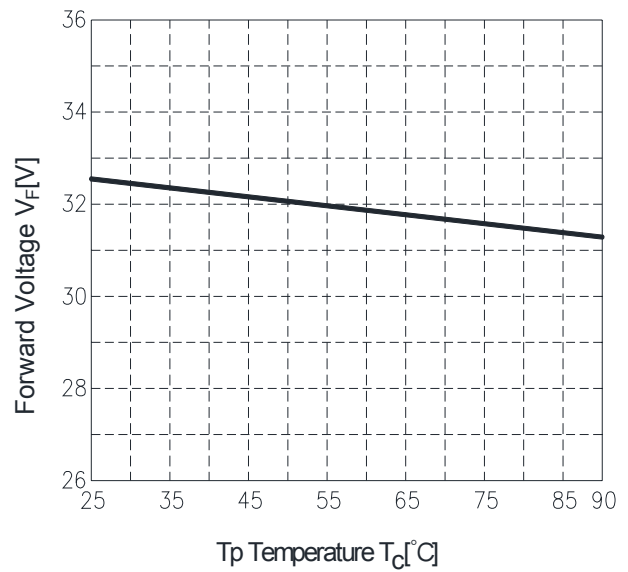

(measuring point for Tp Temperature)

Please ensure the maintenance of heat radiation not to exceed Tp temperature over the rating in operation.

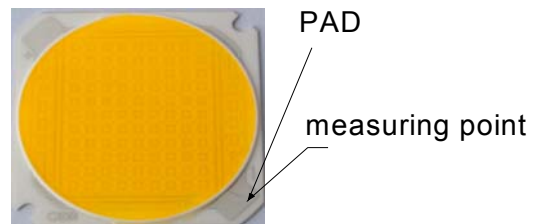

Electrical Characteristics

Relative Luminous.Flux($T_c=25^\circ\text{C}$) vs.Forward Current

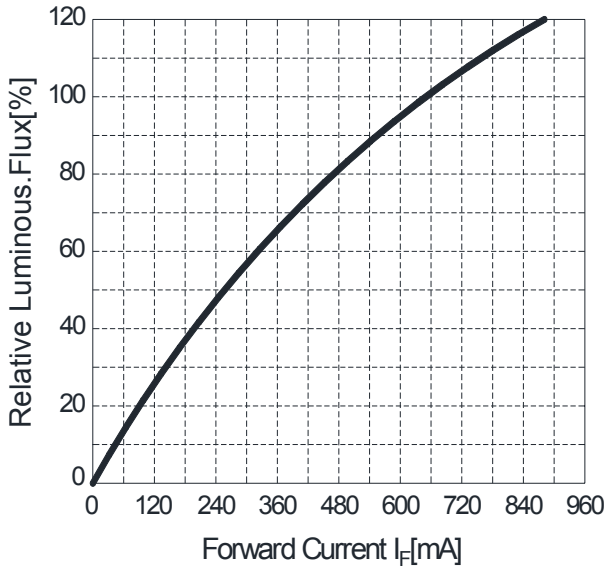

Forward Current($T_c=25^\circ\text{C}$) vs.Forward Voltage

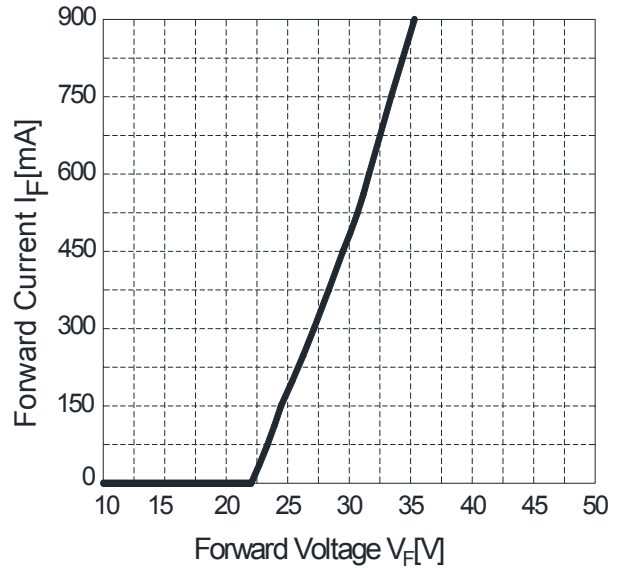

Derating Curves characteristics

Forward Current Derating Curve

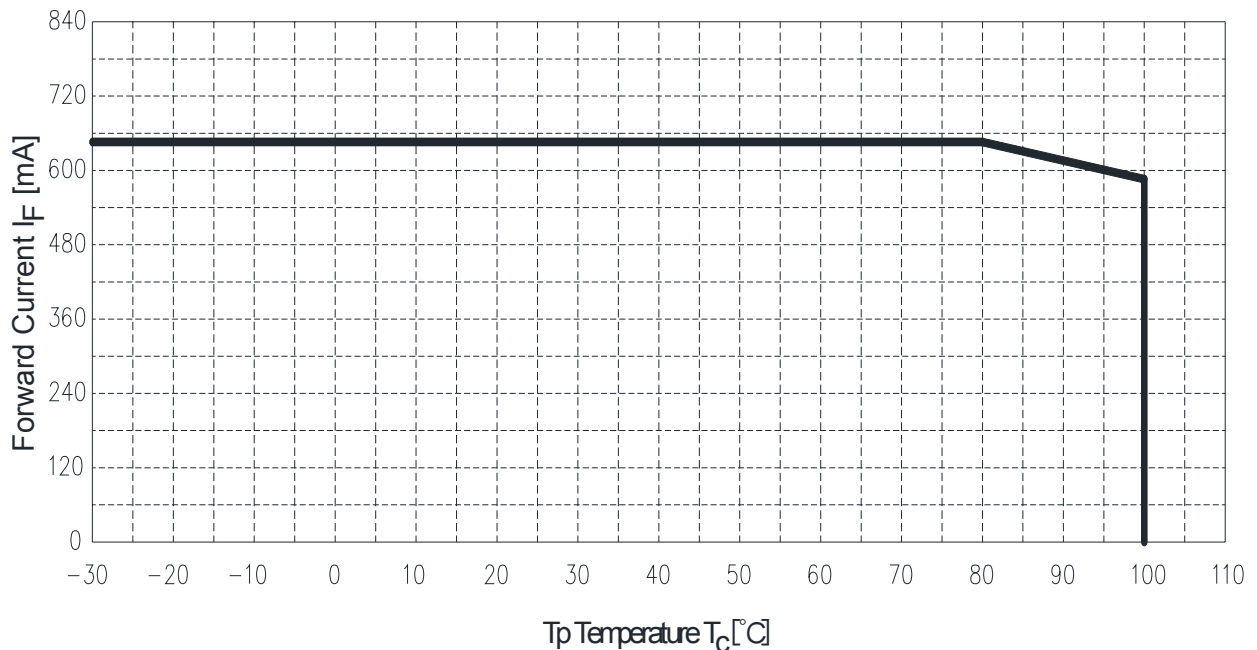

To keep T_p (PAD-temperature) lower than rating enough heat-radiation performance needs to be secured by using an adequate heat sink.

Typical Polar Radiation Pattern

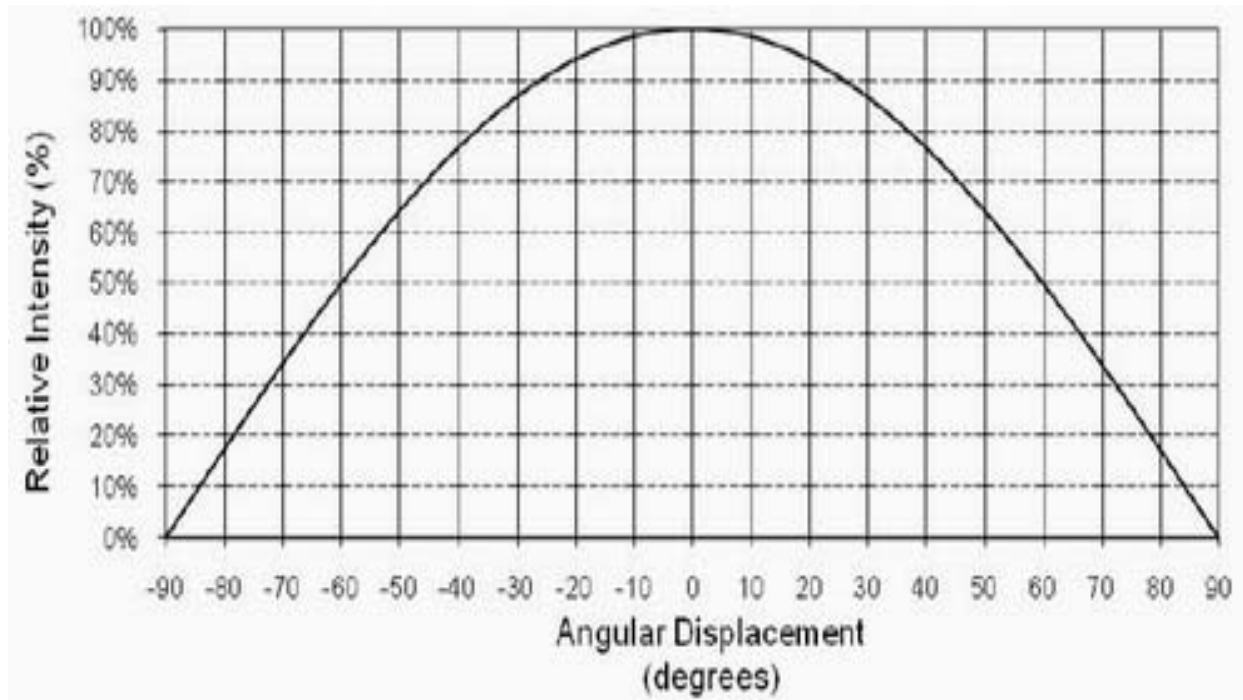

Typical Spatial Radiation Pattern

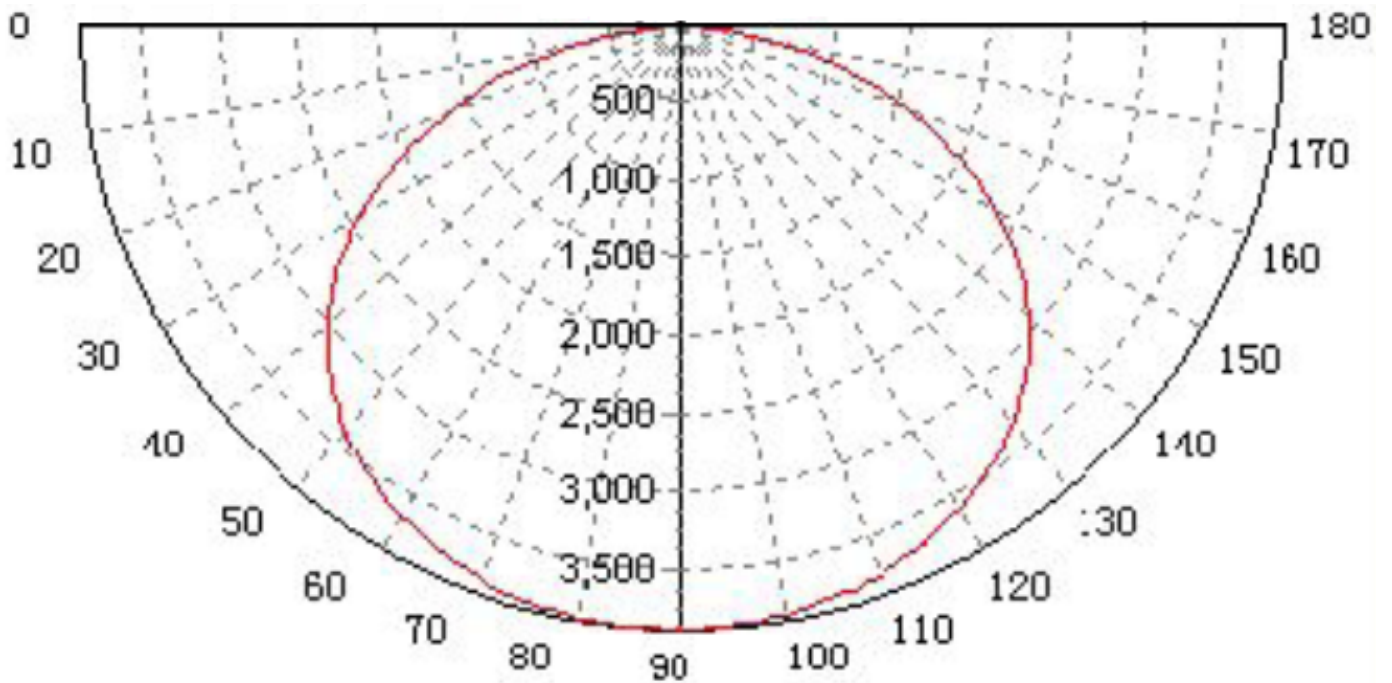

Typical Polar Radiation Pattern

Order Code

LC OB35-10W0 30 XX E R80 0400
X1 X2 X3 X4 X5 X6 X7 X8

Part Number System:

X1: "LC" Abbr."Lightspot Ceramic COB"

X2: COB LED Outline Size: 4008、4012、6012; OB25、OB35、OB50

X3: Power. 10W0 repents 10Watt

X4: Color temperature: 27、30、35、40、45、50、57、65...

X5: Chip specification

X6: Lumen range, 如: $70\text{lm/w} \leq E < 90\text{lm/w}$; $90\text{lm/w} \leq F < 110\text{lm/w}$;

$110\text{lm/w} \leq G < 130\text{lm/w}$

X7: Color rendering Index(CRI): $55 \leq R55 < 60$; $60 \leq R60 < 65$; $65 \leq R65 < 70$; $70 \leq R70 < 75$

$75 \leq R75 < 80$; $80 \leq R80 < 85$; $85 \leq R85 < 90$; $90 \leq R90 < 95$

H: Standard Forward Current. 0400 repents 400mA

NOTICE:

- All dimensions are in millimeter.
- Tolerance is $\pm 0.1\text{mm}$ unless otherwise noted.
- It is strongly recommended that the temperature of lead be not higher than 60°C .
- This information in this document is subject to change in order to improve reliability, design or function without prior notice and does not represent a commitment on the part of this company.
- Avoids preserving in the high temperature, the high-moisture, as well as in the acidic environment .